

## Appendix A.

### Ball Valve Installation Instructions

For Valves:  
 ZC9746, QC9746, NC9746, C9745,  
 QC7094, ZC7094, NC7094, NC7095,  
 C2532, QC7095, ZC7095, C7093.

1.

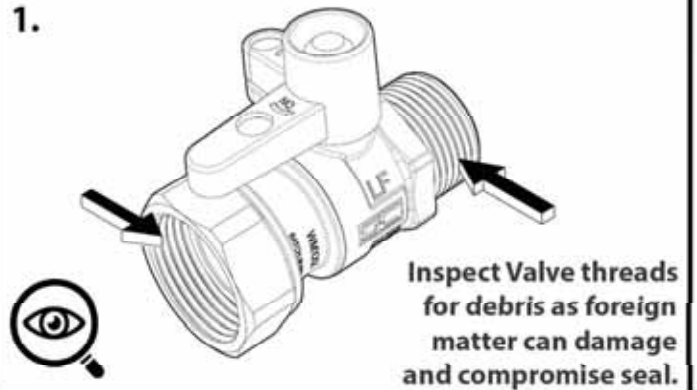

2.

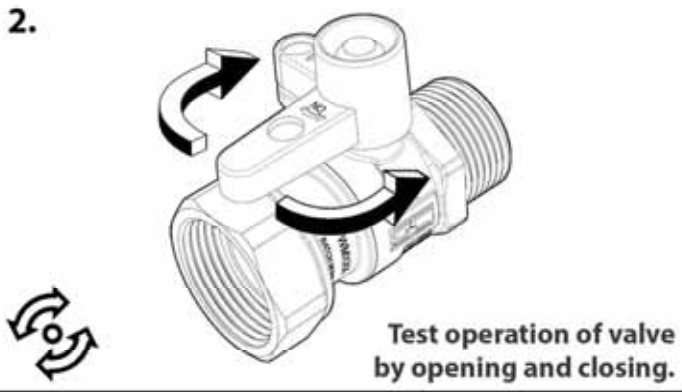

3.

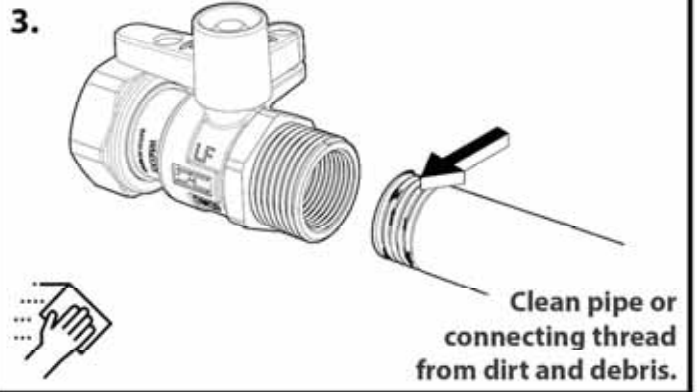

4.\*

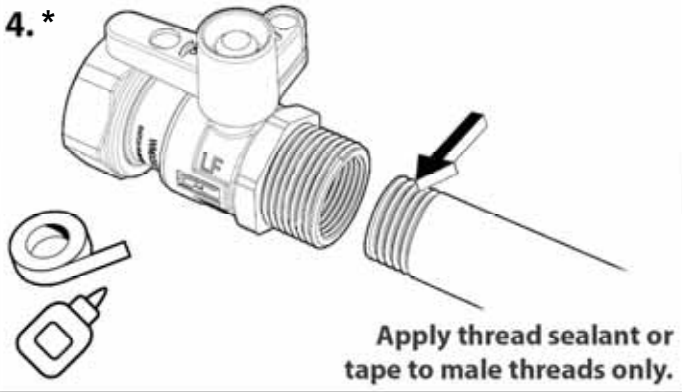

5.

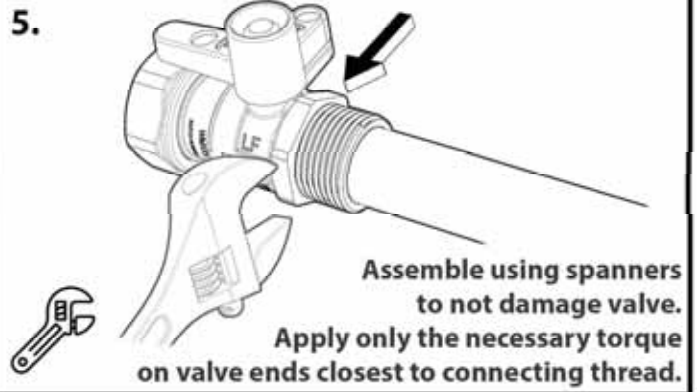

6.

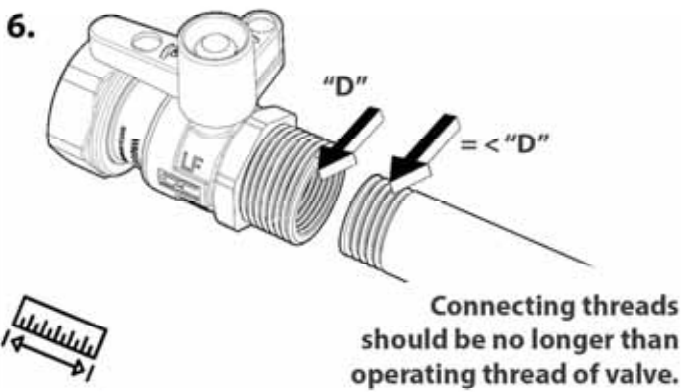



7.



## Appendix B

### Dual Check Valves Installation Instructions

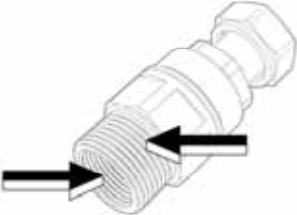
For Dual Check Valves: ZC707920, QC707920, C707820, ZC707925, QC707925, C707825

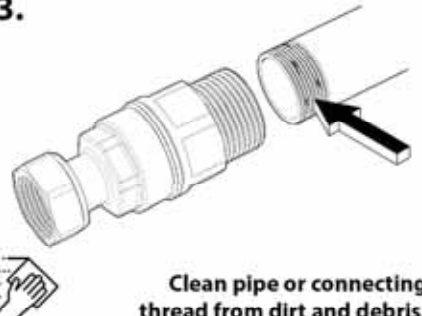
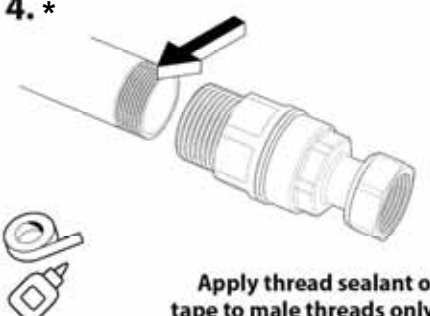
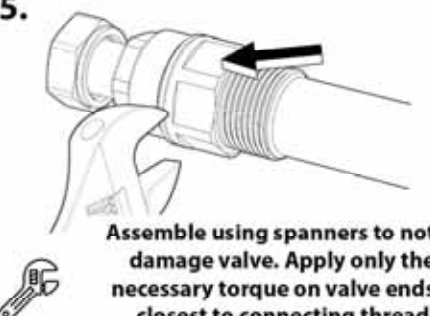
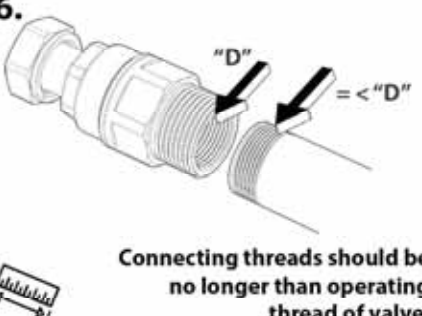
<p><b>1.</b></p>  <p>Inspect Valve threads for debris as foreign matter can damage and compromise seal.</p>	<p><b>2.</b></p>  <p>Test operation of dual check valve by pressing plunger in to ensure spring is working.</p>	<p><b>3.</b></p>  <p>Clean pipe or connecting thread from dirt and debris.</p>
<p><b>4. *</b></p>  <p>Apply thread sealant or tape to male threads only.</p>	<p><b>5.</b></p>  <p>Assemble using spanners to not damage valve. Apply only the necessary torque on valve ends closest to connecting thread.</p>	<p><b>6.</b></p>  <p>Connecting threads should be no longer than operating thread of valve.</p>



(For connections to PE pipe, please refer to Appendix D.)

(note 4\* AS4020:2018 approved thread tape / sealants only)

## Appendix C

### Maintenance of Dual Check Valves

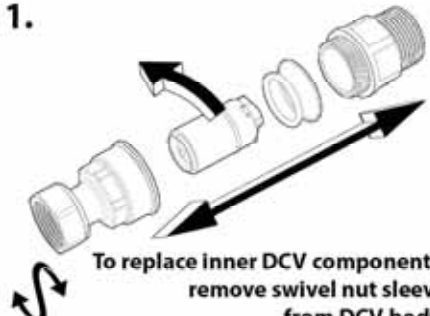
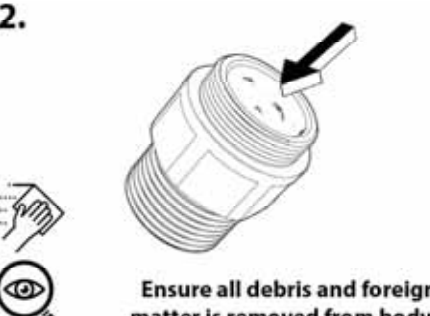
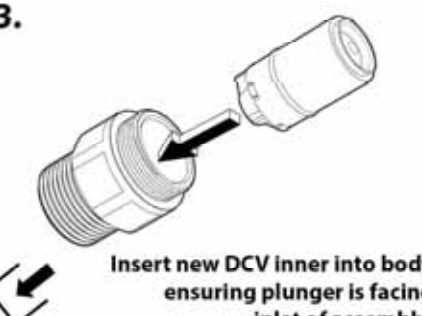
For Dual Check Valves: ZC707920, QC707920, C707820, ZC707925, QC707925, C707825

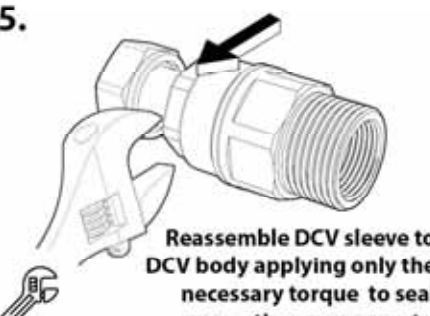
<p><b>1.</b></p>  <p>To replace inner DCV components, remove swivel nut sleeve from DCV body.</p>	<p><b>2.</b></p>  <p>Ensure all debris and foreign matter is removed from body.</p>	<p><b>3.</b></p>  <p>Insert new DCV inner into body ensuring plunger is facing inlet of assembly.</p>
<p><b>4. *</b></p>  <p>Inspect sleeve is free from debris and O-ring is positioned correctly. Apply non-toxic lubricant on O-rings if required.</p>	<p><b>5.</b></p>  <p>Reassemble DCV sleeve to DCV body applying only the necessary torque to seal connecting components.</p>	

(note 4\* AS4020:2018 approved non-toxic lubricants only)

## Appendix D.

### Mechanical Compression Unions for Polyethylene Pipe

Valves: QC7094, ZC7094, NC7094, NC7095,  
 QC7095, ZC7095, C2532, C7093.

Fittings: ZC7079, QC7079, C7078, PS4000.

Dual Check Valves: ZC707925, QC707925,  
 C707825 Meter Housing

1.



2.

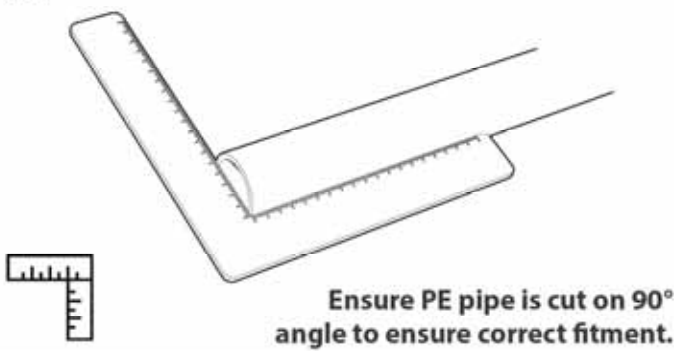

3.\*

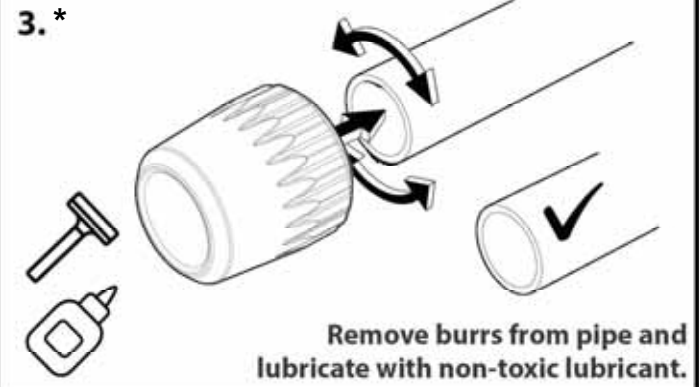

4.



5.

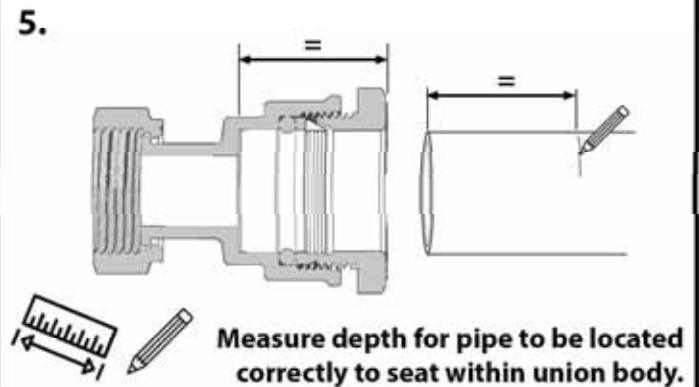

6.

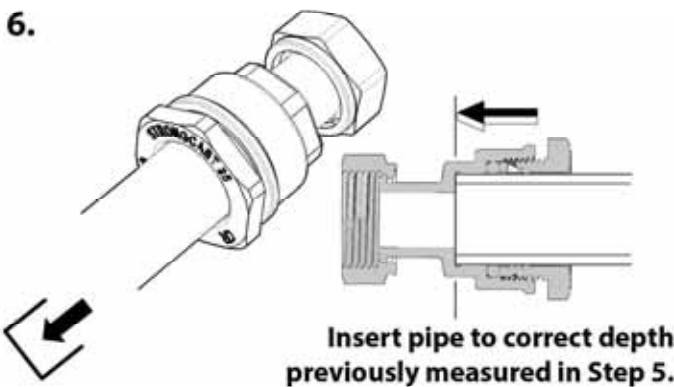

7.

